

Joinery Options

Joinery Systems and Options

Southern41™ Thermal System

Southern41™ Thermal



Window	Bifold Window	Hinged Door	Bifold Door	French Door
Max Sash Size 1.6m x 0.8m	Max Sash Size 1.6m x 0.8m	Max Panel Size 2.4m x 0.9m	Max Panel Size 2.4m x 0.9m	Max Panel Size 2.4m x 0.9m
Frame Size 47mm LW Rebate 57.5mm	Frame Size 47mm LW Rebate 57.5mm	Panel Thickness 50mm Frame Size 47mm LW Rebate 57.5mm	Panel Thickness 50mm Frame Size 47mm LW Rebate 57.5mm	Panel Thickness 50mm Frame Size 47mm LW Rebate 57.5mm

*Not recommended to be used as Bifolds and french doors can have ongoing maintenance issues.

Sliding windows are available they use Sliding Door Bar - all parameters as per below.

Sliding Doors

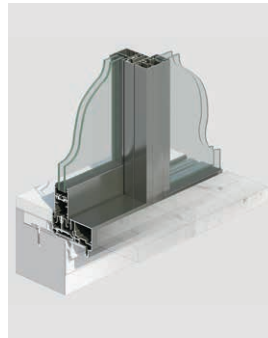
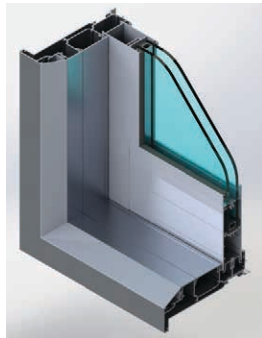

Ranchslider Inside Slide	Ranchstacker Inside Slide	LevelStep Inside Slide	Euroslider Outside Slide	Eurostacker Outside Slide
Up to very high wind	Up to very high wind	Up to very high wind	Up to extra high wind	Up to extra high wind
Max Panel Size wide style 2.7m x 2.2m	Max Panel Size wide style 2.7m x 2.2m	Max Panel Size wide style 2.7m x 2.2m	Max Panel Size wide style 2.7m x 2.2m	Max Panel Size wide style 2.7m x 2.2m
Sash Option	Sash Option	Sash Option	No Sash	No Sash
Frame Size 106mm LW Rebate 116.5mm	Frame Size 106mm LW Rebate 116.5mm	Frame Size 106mm LW Rebate 116.5mm	Frame Size 96mm LW Rebate 106.5mm	Frame Size 96mm LW Rebate 106.5mm

Panel Thickness 50mm

Max IGU 25mm

Panel capacity dependent on size, windload and weight. Support bar required when panel over 75kg.

Multistackers available on request. (3 panel bipass/internal stackers): RS Frame Size 160mm, LW Rebate 170.5mm
Euro Frame Size 158mm, LW Rebate 168.5mm (use MP subframe).

LevelStep sliders are not suitable for beach front properties or extra high wind zones.

*Larger sized frames are available on request. Please Contact technical@lockwood.co.nz for advice.

Tasman35 System

Tasman35™



Window
Max IGU 25mm
Frame Size 47mm
LW Rebate 57.5mm

Bifold Window
Max IGU 25mm
Frame Size 47mm
LW Rebate 57.5mm

Hinged Door
Max Panel Size
2.4m x 1.0m
Panel Thickness 41mm
Frame Size 47mm
LW Rebate 57.5mm

Bifold Door
Max Panel Size
2.4m x 0.85m
Panel Thickness 45mm
Frame Size 47mm
LW Rebate 57.5mm
(*Alternate Bar Used)

French Door
Max Panel Size
2.4m x 0.9m
Panel Thickness 50mm
Frame Size 47mm
LW Rebate 57.5mm

*Not recommended to be used as Bifolds and french doors can have ongoing maintenance issues.

Sliding windows are available they use Sliding Door Bar - all parameters as per below.

Sliding Doors

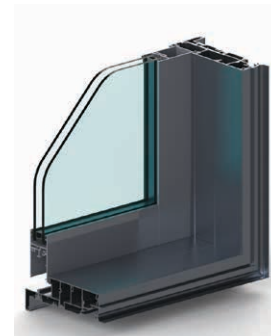
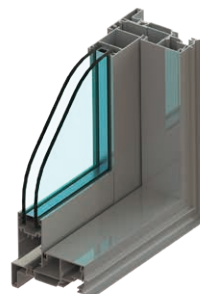
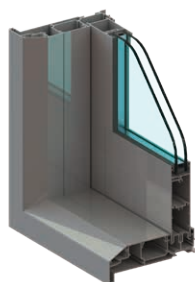
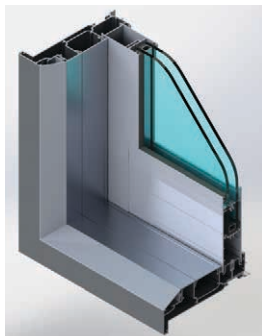

Ranchslider™
Inside Slide
Up to very high wind
Max Panel Size wide style
2.4m x 1.5m
Sash Option
Frame Size 47mm
LW Rebate 57.5mm

Ranchstacker™
Inside Slide
Up to very high wind
Max Panel Size wide style
2.4m x 1.5m
Sash Option
Frame Size 94mm
LW Rebate 104.5mm

LevelStep
Inside Slide
Up to very high wind
Max Panel Size wide style
2.4m x 1.5m
Sash Option
Frame Size 94/47mm
LW Rebate 104.5/57.5mm

Euroslider
Outside Slide
Up to extra high wind
Max Panel Size wide style
2.4m x 1.5m
No Sash
Frame Size 94mm
LW Rebate 104.5mm

Eurostacker
Outside Slide
Up to extra high wind
Max Panel Size wide style
2.4m x 1.5m
No Sash
Frame Size 94mm
LW Rebate 104.5mm

Panel Thickness 36mm
Max IGU 25mm

Panel capacity dependent on size, windload and weight. Support bar required when panel over 75kg.

Multistackers available on request. (3 panel bipass/internal stackers - alternate system): Frame Size 159.5mm, LW Rebate 161.5mm.

Pacific41 System to be used in SED wind zones.

LevelStep sliders are not suitable for beach front properties or extra high wind zones.

*Larger sized frames are available on request. Please Contact technical@lockwood.co.nz for advice.

Hardware

Hinged/Entrance Doors



Aria Pinnacle (Std)
- Colourcoded



Acacia Pinnacle
- Colourcoded



Verta Long Plate
Lever (Euro Cylinder)
- Satin Stainless
Steel or PVD Black



Yale Smart Lock 60mm
Backset
- Silver/Black



Yale YDM7220
Digital Door Lock
- Black



Yale Digital Keypad
(Deadbolt)
*Couple with handle of choice



Apex Square Pull Handle
60mm Offset
300/450/600mm
- Brushed Nickel
- Stainless Option



Apex Round Pull
Handle
300/450/600mm
- Brushed Nickel
- Stainless Option



Century
Entrance Set
- Satin Chrome



Plymouth Entrance
Set
- Satin Chrome
- Satin Nickel Plate Option
- Polished Brass Option



Verta Entrance
Pull Handle
- Satin Stainless
Steel or PVD Black



Nitro D Handle 450/600mm
Suitable for Extra High
situations.
- Colourcoded
- Matt Black Option
- Brushed Nickel Option

Sliding Doors



Aria D Handle (Std)
- Colourcoded



Snibbed/Keyed



Verta Offset Pull Handle
- Satin Stainless
Steel or PVD Black

Bifold Doors



Aria Twinbolt
- Colourcoded



Verta Bifold Operator
- Satin Stainless
Steel or PVD Black

Notes: Hardware Parameters

- Lockbody is located 990mm off floor level.
- Handles are installed above this i.e. - Aria D handle will be 1080mm to floor from bottom of handle.

Hardware

Sliding Window



Doric Flush Pull
DN551 (Std)

- Colourcoded



Aria Endeavour

- Colourcoded

Window Latches



Helix (Std)

- Colourcoded



Verta High Profile

- Satin Stainless Steel
or PVD Black



Verta Low Profile

Use in sliders & stackers
- Satin Stainless Steel or
PVD Black

Pet Doors



Pet-Corp Versatile
Cat Door - White
PC2-W



Pet-Corp Versatile
Dog Door - White
PC3-W

Patio Bolts



Yale Patio Bolt
CYL4 LS

- Colourcoded

Restrictor Stays



Interlock I Assa Abloy
R130
Stainless Steel

Doors



Std Door Width 837mm / Door Panel 40mm

Max Door Width 950mm (Please check as this is selection specific)

Max Height 13 Board Frame

R Values are as-built in Southern41 Thermal frame.

Note: Extra High - clearance issues from required Box Mullion mean pull handles need to be D Handle.

Traditional



SR1
R0.34

SR2
R0.32

SR8
R0.30

SR3
R0.32

SR4
R0.32

SR5
R0.31

SR6
R0.32

SR7
R0.30

Tongue & Groove - Frameless



SR11
R0.26

SR19
R0.26

SR20
R0.26

Tongue & Groove - Frameless



SR9
R0.27

SR10
R0.26

SR12
R0.27

Modern



SR13
R0.37

SR14
R0.37

SR15
R0.37

SR16
R0.37

Door Parameters when sourcing alternate supply

- Door Panel can be 40mm or 50mm thick
- Panel size needs to suit board increments. See below:
 - Heights (std detailing)
 - 12 boards - 1955mm
 - 13 boards - 2127mm
 - 14 boards - 2299mm
- Width Std 834mm

Quick Reference

Hinged Doors

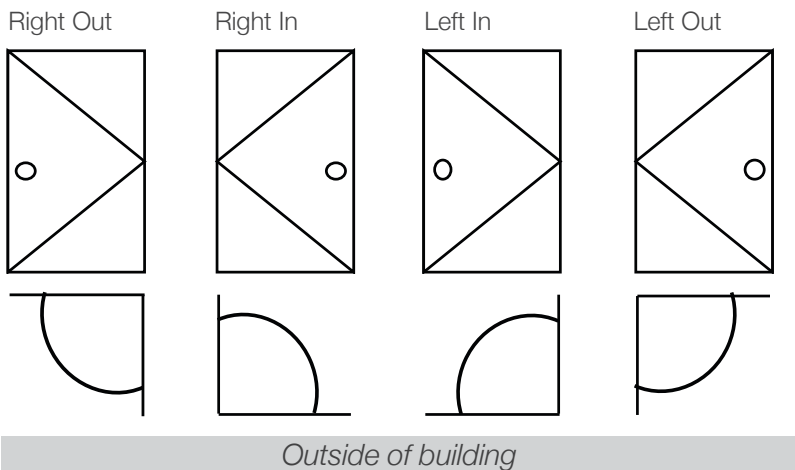

Sliding Doors

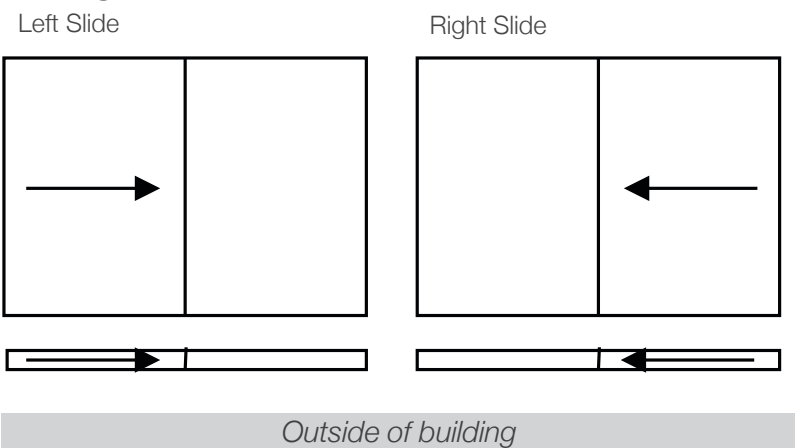

Locking Options

- Deadlock
- Lock both sides
- Key/Turn
- Lock outside with turn inside
- Key/Remove Turn (Securiturn)
- Snib inside
- Patio
- Turn inside only
- Patio Lock
- Deadlock to inside only
- Patio RT (Securiturn)
- Removable snib inside only

O/A Subframe sizes

- E = 516 (3 board)
- T = 688 (4 board)
- D = 860 (5 board)
- J = 1032 (6 board)
- H = 1204 (7 board)
- N = 1376 (8 board)
- R = 1548 (9 board)
- Z, P, F = 2083 Full height

Glazing options from

All Metro Low-E glass options achieve R0.50 in Southern 41 thermally broken joinery and R0.37 in Tasman 35 joinery as per Table E1.1.1 of H1/AS1 5th Edition.

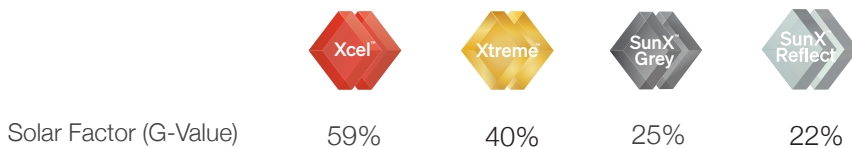

For more information head to: https://assets.metroglass.co.nz/files/products/windows_and-doors/double-glazing-range-brochure_web_m008aug24.pdf

Obscure Glass Options

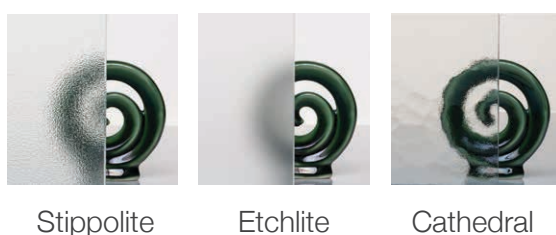

Tinted Glass Options:
Grey, Green, Bronze

Standard Joinery Suite

Full customisation of joinery configuration is possible as long as the height is in board height increments.

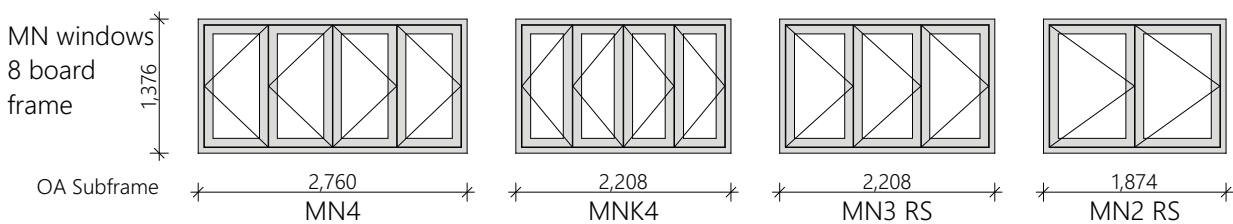
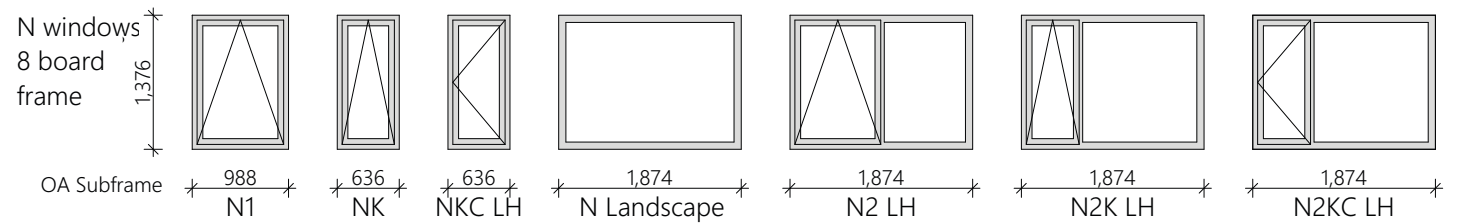
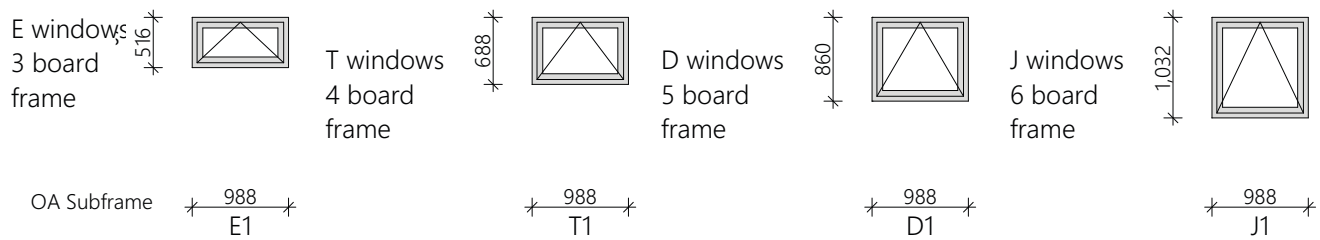
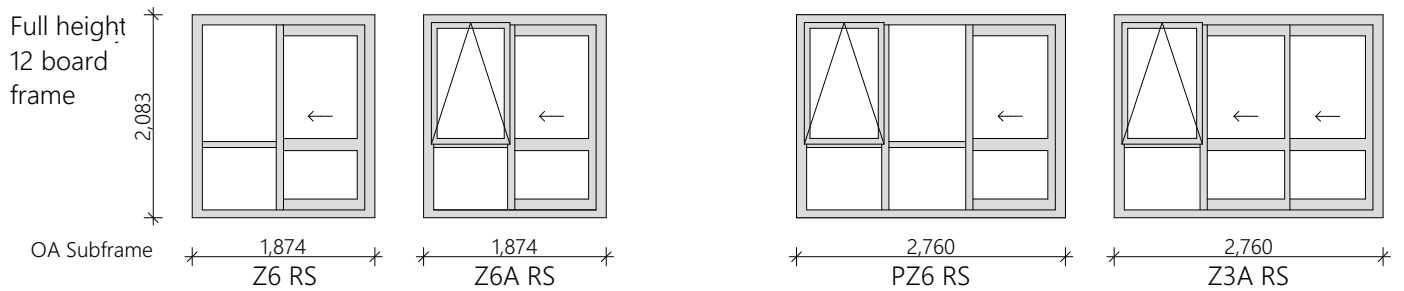
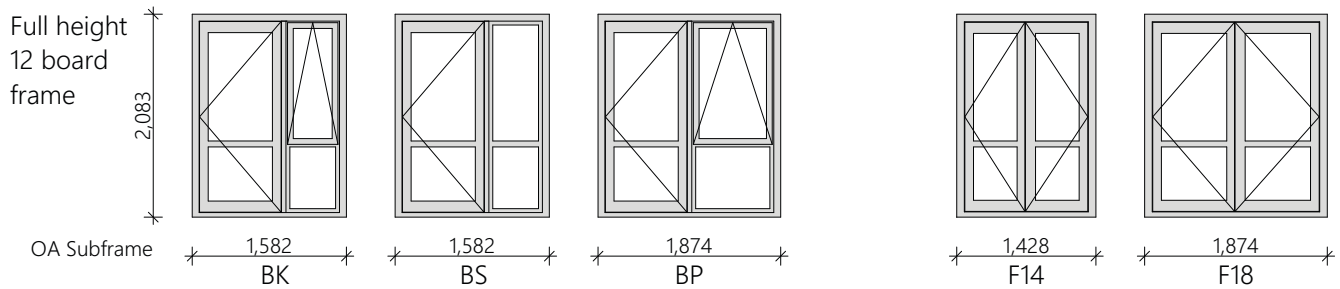
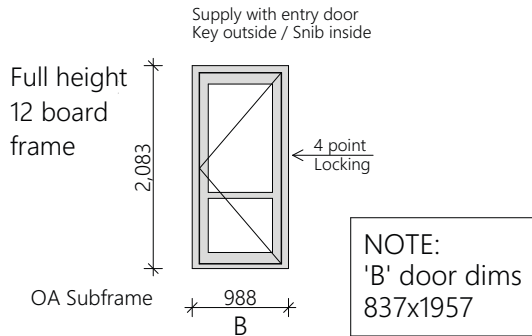

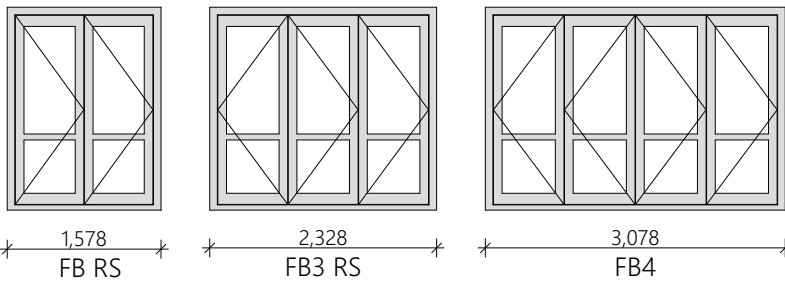
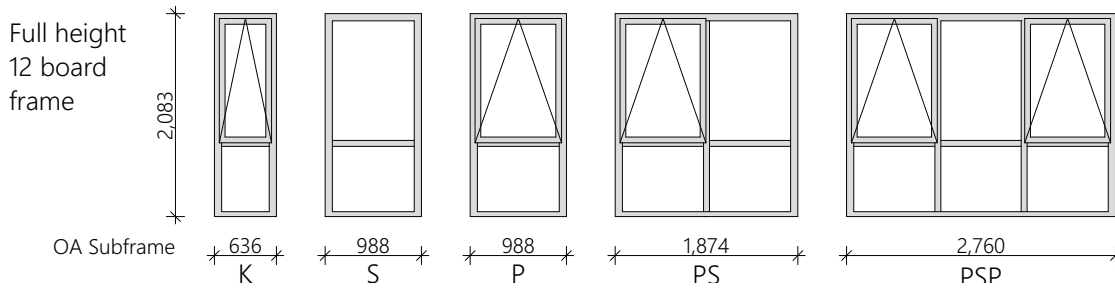

*Not recommended
to be used as Bifolds
can have ongoing
maintenance issues.

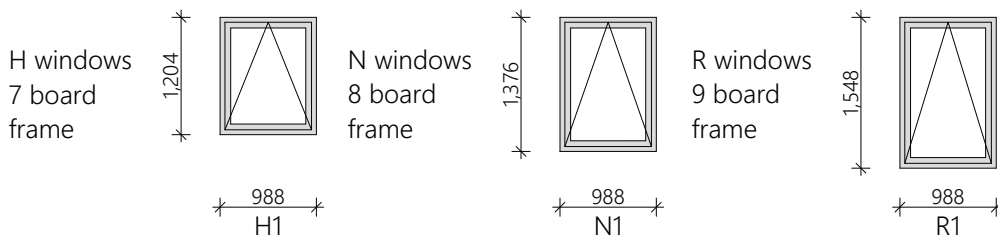
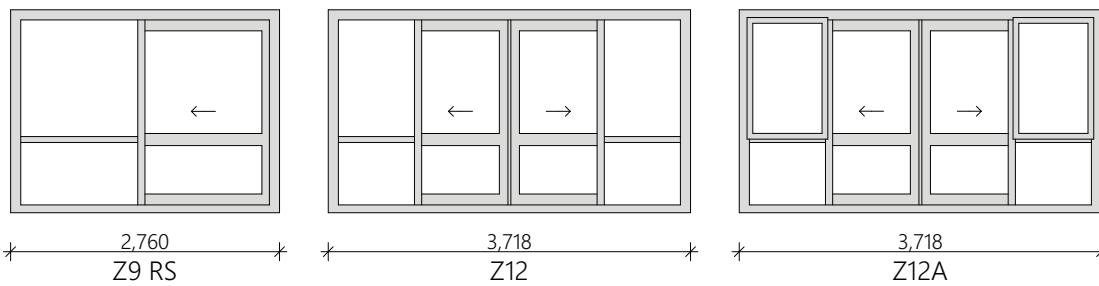

This row of Joinery is also
available in the same options
as the N range.

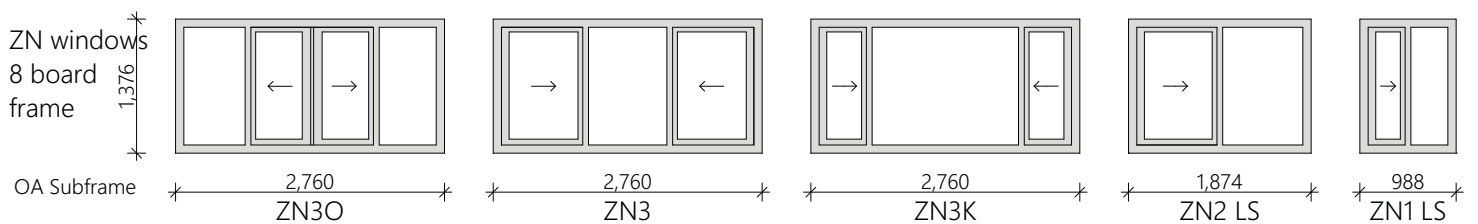
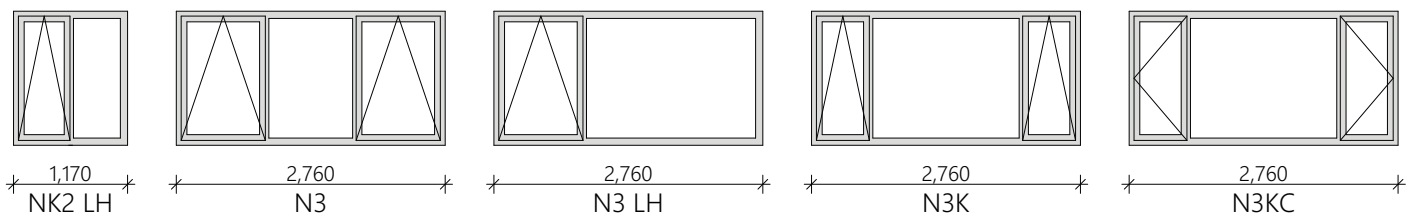

AMBIANCE UPVC WINDOW SYSTEM

STÄRKE

For warmer, drier, healthier homes

COLOURS



BLACK

- ▶ Aludec lamination technology for UV and heat protection
- ▶ Powdercoat match: Flaxpod
- ▶ Profile coloured throughout



WHITE

- ▶ Powdercoat match: Appliance White
- ▶ UV protection
- ▶ Profile coloured throughout

GLAZING OPTIONS



	CLEAR	LIGHTBRIDGE 1.1	PERFORMATECH
R-VALUE	R0.40	R0.74	R0.74
G-VALUE	0.77	0.59	0.38
VLT	88%	79%	72%

R-values are an average for the STÄRKE Ambiance uPVC system. Table E1.1.1 of H1/AS1 5th edition specifies R0.69 for uPVC with Lightbridge and Performatech

AMBIANCE SPECIFIERS DESIGN GUIDE

Further information available in the STÄRKE Ambiance Specifiers Design Guide.



Scan QR or [Click Here](#)

WINDOWS



AWNING

Opening sizes:
 Max 1400w x 1600h
 Min 600w x 600h
 *refer to awning size matrix in
 Ambiance Specifier Guide
 Up to SED Wind Zone



TILT & TURN

Opening sizes:
 Max 1600w x 2400h
 Min 600w x 600h
 Up to SED Wind Zone



SLIDING

Opening sizes:
 Max 5800w x 2400h
 Min 1200w x 700h
 Up to Very High Wind Zone



STACKING

Opening sizes:
 Max 5800w x 2400h
 Min 1200w x 700h
 Up to Very High Wind Zone

DOORS



SINGLE

Opening size
 Max 1200w x 2600h
 Low sill option
 Up to SED Wind Zone



FRENCH

Opening size
 Max 2400w x 2600h
 Low sill option
 Up to SED Wind Zone



SLIDING

Opening sizes:
 Max 5800w x 2400h
 Min 1200w x 700h
 Up to Very High Wind Zone



STACKING

Opening sizes:
 Max 5800w x 2400h
 Min 1200w x 700h
 Up to Very High Wind Zone

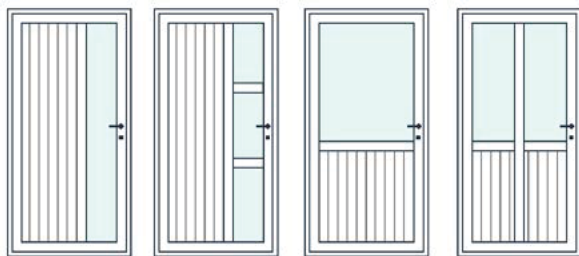

ENTRY DOOR EXAMPLES

Entry doors can be configured from uPVC and glass combinations.
 Max opening size 1200w x 2600h
 Up to SED Wind Zone

HARDWARE



VITA LEVER

Suitable for use on:
 - Awning Windows



1033 LEVER

Suitable for use on:
 - Tilt & Turn
 - Sliding
 - Stacking



1033 LEVER

Suitable for use on:
 - Single Door
 - French Door



DIGITAL E-LOK

Suitable for use on:
 - Single Door
 - French Door



LOCKWOOD

Designed for good

ENTRY DOORS



Thermtek - Thermally enhanced door boasts an R-Value of 0.73 for a 1980 x 860mm door and serves as a superior noise barrier. It effectively reduces condensation. Designed to grow and shrink with the elements, with very minimal bowing. The design innovation combines aluminium with 'pultrusion' a new material in doors that is structurally sound and is an excellent insulator. Available in thicknesses of 41mm or 50mm thick.



ATFL00



ATHV03



ATVV03



ATSV03



ATSV04



ATHV00

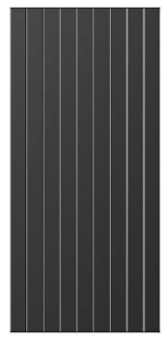

ATVV00



ATVV51



ATFL10



ATFL11



ATFL24



ATVV01



ATVV10



ATVV11



ATVV24



TH10TV



TH44T

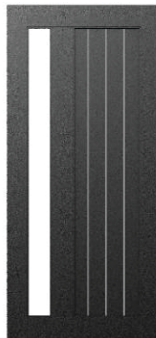

TH11T



TH3L



TH6P



Regal Square Pull Handle Lockset
Black, Gun Metal or Stainless Steel
600mm Pull



Colonel Round Pull Handle Lockset
Black, Gun Metal or Stainless Steel
600mm Pull



E-LOK 905 Digital Lock
2 point or Multipoint
Black, Stainless Steel, Satin Brass or Gun Metal



Resolute Digital Lock
2 point or Multipoint
Black or Silver



Zest Entry Lever Set
Black or Stainless Steel

Lockwood Timber Doors

Lockwood Interior Doors are supplied standard as paint quality preprimed hollow core (RibCore) doors with the 4mm skin. Standard dimensions of 2030mm x 38mm thick for passage doors or 1980mm for some sliding wardrobe doors. Door frames are manufactured in the Lockwood factory and include checkouts for door handles. Doors come complete with hinges, striker plates and door hardware. Stainless hinges are available for seaspray environments. Overheight doors are available with a maximum door height of 14 boards / 2374mm.

Solid Core Options:

Expanded Polystyrene (EPS) Solid Core (Standard)

As an alternative to a standard heavy solid particle board core door, Superior Doors provides the option of the Premium High Density Solid EPS Polystyrene Core. The High Density EPS Polystyrene Solid Core further enhances thermal insulation, as well as providing even greater impact resistance. The EPS core does all this while being cost effective, safer and easier to handle than traditional solid core doors.

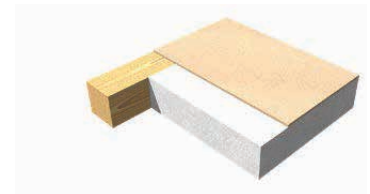

Moisture Resistant (MR) Particle Board Solid Core (Optional Extra)

*Commercial application

For those who require a door with maximum impact resistance we offer the MR Particle Board solid core option. The MR Particle Board Core is more moisture resistant than standard particle board and is the ultimate core option for strength, durability and is the best core option for acoustic insulation.



Grooved Door Design (Optional Extra)

AVON

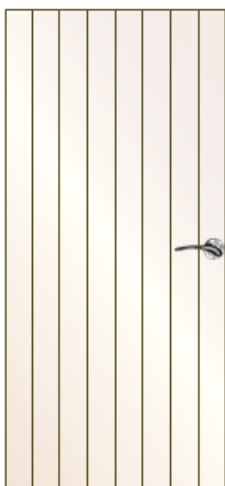

HEADLAND



*Others available refer superiorsdoors.co.nz - the Superior Doors brochure.

Standard Lockwood Interior Doors

Available in either left hung/right hung.

Available door sizes are: 410, 460, 510, 560, 610, 660, 710, 760, 810, 860, 910mm.

Over height available

13/14 boards.

Interior Doors

Hardware - Passage or Privacy set, Hinges

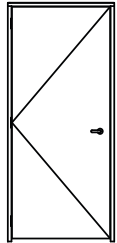

A-Door

Available 410-910mm

Sliding Doors

Hardware - Flush Pull, Sliding Track

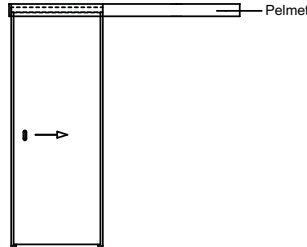

S-Door

Available 610-860mm

Wardrobe Doors

Hardware - Dummy Trims and Hinges

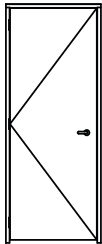

W1

Available 410-810mm

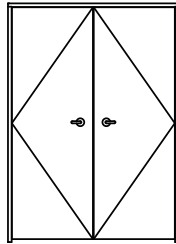

W2

Available 2/410-2/810mm

Over Cupboards

Hardware - Dummy Trims and Hinges

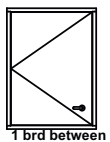

1 brd between

TW1

Available 410-810mm

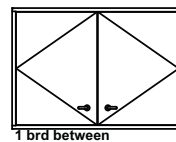

1 brd between

TW2

Available 2/410-2/810mm

Sliding Wardrobe Doors

Hardware - Flush Pull, Sliding Track

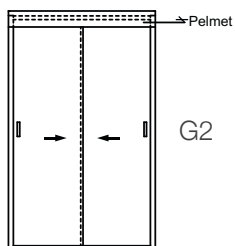

G2

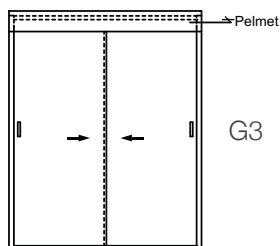

G3

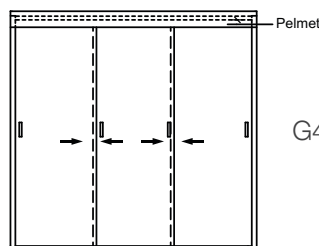

G4

Available 610-810mm

Schlage **Medio Series**

Modern styles for everyday living.

Enhance your home's architectural elements with the Schlage Medio range of modern, contemporary door furniture.

Blending contemporary styling with uncompromising quality, the Medio Series is designed for everyday living. Reflect your own unique design style with a choice of architecturally inspired levers to complement your modern interior design.

Sleek design

- Modern lever designs and finishes
- Built-in privacy push-button for ease of use
- Through-bolt secure fixing concealed by a classic round rose design
- Complementary range of accessories

Durable construction

- Lever and rose constructed of high purity zinc alloy
- High quality electroplated finishes including aged, brushed copper and matt black

Levers



Rivera

Matt Black



Sierra

Matt Black



Flush pull

Matt Black



Rivera*

Aged Brushed Copper



Sierra*

Aged Brushed Copper



Flush pull

Aged Brushed Copper

*Shown as privacy

Material

- Zinc die cast lever and rose
- Brass cap

Functions

- Passage, privacy and dummy trim

Warranty

- 10 year mechanical
- One year finish for Aged Brushed Copper & Matt Black

Schlage **Form Series**

Forward looks for forward thinkers.

Clean lines, crisp edges. Sleek and sophisticated, yet imminently approachable. A modern look with minimal styling means maximum impact.

The Schlage Form Series is beautifully designed contemporary door furniture manufactured in high quality satin stainless steel with a wide range of lever styles to suit all modern day interiors.

Sleek design

- Contemporary lever designs
- Built-in privacy push-button for ease of use
- Through-bolt secure fixing concealed by a classic round rose design

Durable construction

- Solid stainless steel levers and outer ring, die cast inner roses



Albo



Angelo



Costa



Kanso



Stefano



Telo



Material

- Solid stainless steel lever, US304 grade
- Zinc die cast rose

Functions

- Latch furniture, passage, privacy and dummy trim

Warranty

- 10 year mechanical and finish

Allegion (New Zealand) Limited
Freephone 0800 477 869
Email nzinfo@allegion.com
www.allegion.co.nz

 **LOCKWOOD**
Designed for good